

Limit switches

XC Standard range
Industrial format EN 50041
Metal, XCKJ
Conforming to CENELEC EN 50041

■ XCKJ

fixed body with 1 cable entry

□ With head for linear movement (plunger)

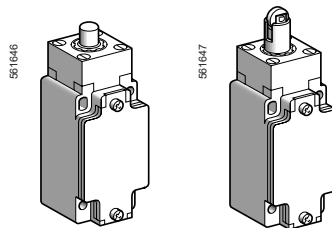

Page 146

□ With head for rotary movement (lever)

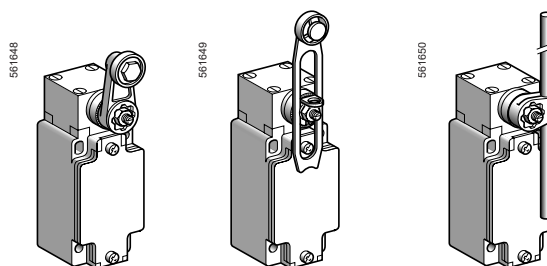

Page 146

■ XCKJ

plug-in body with 1 cable entry

□ With head for linear movement (plunger)

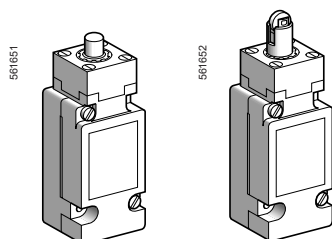

Page 148

□ With head for rotary movement (lever)

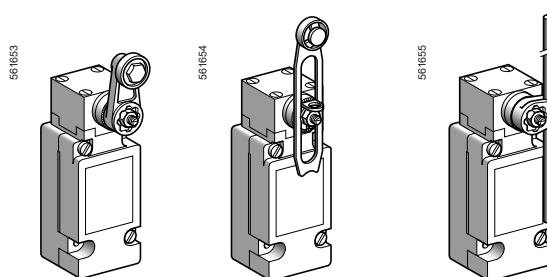

Page 148

Environment characteristics

Conformity to standards	Products	CE, IEC 60947-5-1, EN 60947-5-1, UL 508, CSA C22-2 n° 14, EAC
	Machine assemblies	IEC 60204-1, EN 60204-1
Product certifications		UL, CSA, CCC, BV
Protective treatment	Version	Standard: "TC", special: "TH"
Ambient air temperature	For operation	- 25...+ 70°C, special sub-assemblies for use at - 40°C or + 120°C
	For storage	- 40...+ 70°C
Vibration resistance	Conforming to IEC 60068-2-6	25 gn (10...500 Hz)
Shock resistance	Conforming to IEC 60068-2-27	50 gn (11 ms)
Electric shock protection		Class I conforming to IEC 61140 and NF C 20-030
Degree of protection		IP 66 conforming to IEC 60529; IK 07 conforming to IEC 62262
Repeat accuracy		0.01 mm on the tripping points, with 1 million operating cycles for head with end plunger
Cable entry or connector	Depending on model	Tapped entry for Pg 13.5 cable gland, tapped ISO M20 x 1.5 or tapped 1/2" NPT, or M12 connector
Materials		Bodies and heads in Zamak

Contact block characteristics

Rated operational characteristics	XE2●P	~AC-15; A300 (Ue = 240 V, Ie = 3 A); Ithe = 10 A ---DC-13; Q300 (Ue = 250 V, Ie = 0.27 A), conforming to IEC 60947-5-1 Appendix A, EN 60947-5-1
	XE3●P	~AC-15; B300 (Ue = 240 V, Ie = 1.5 A); Ithe = 6 A ---DC-13; R300 (Ue = 250 V, Ie = 0.1 A), conforming to IEC 60947-5-1 Appendix A, EN 60947-5-1
Rated insulation voltage	XE2●P	Ui = 500 V degree of pollution 3 conforming to IEC 60947-1 Ui = 300 V conforming to UL 508, CSA C22-2 n° 14
	XE3●P	Ui = 400 V degree of pollution 3 conforming to IEC 60947-1 Ui = 300 V conforming to UL 508, CSA C22-2 n° 14
Rated impulse withstand voltage	XE2●P	U imp = 6 kV conforming to IEC 60947-1, IEC 60664
	XE3●P	U imp = 4 kV conforming to IEC 60947-1, IEC 60664
Positive operation (depending on model)		NC contacts with positive opening operation conforming to IEC 60947-5-1 Appendix K, EN 60947-5-1
Resistance across terminals		≤ 25 mΩ conforming to IEC 60255-7 category 3
Short-circuit protection	XE2●P	10 A cartridge fuse type gG (gl)
	XE3●P	6 A cartridge fuse type gG (gl)
Connection (screw clamp terminals)	XE2SP21●1	Clamping capacity, min: 1 x 0.34 mm ² , max: 2 x 1.5 mm ²
	XE2NP21●1	Clamping capacity, min: 1 x 0.5 mm ² , max: 2 x 2.5 mm ²
	XCKJ plug-in and XESP20●1	Clamping capacity, min: 1 x 0.75 mm ² , max: 2 x 1.5 mm ²
	XE3NP and XE3SP	Clamping capacity, min: 1 x 0.34 mm ² , max: 1 x 1 mm ² or 2 x 0.75 mm ²
Minimum actuation speed		XE2SP21●1 and XE3SP: 0.01 m/minute XE2NP21●1 and XE3NP: 6 m/minute

Electrical durability

- Conforming to IEC 60947-5-1 Appendix C
- Utilisation categories AC-15 and DC-13
- Maximum operating rate: 3600 operating cycles/hour
- Load factor: 0.5

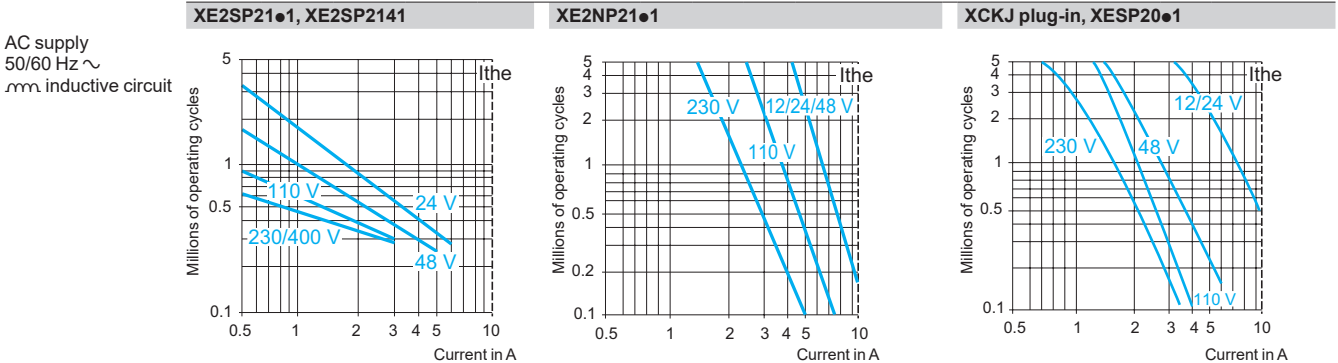

DC supply ---	Power broken in W for 5 million operating cycles.												
	Voltage	V	24	48	120	V	24	48	120	V	24	48	120
	mm	W	10	7	4	W	13	9	7	W	10	7	4

For XE2SP●151 on ~ or ---, NC and NO contacts simultaneously loaded to the values shown with reverse polarity.

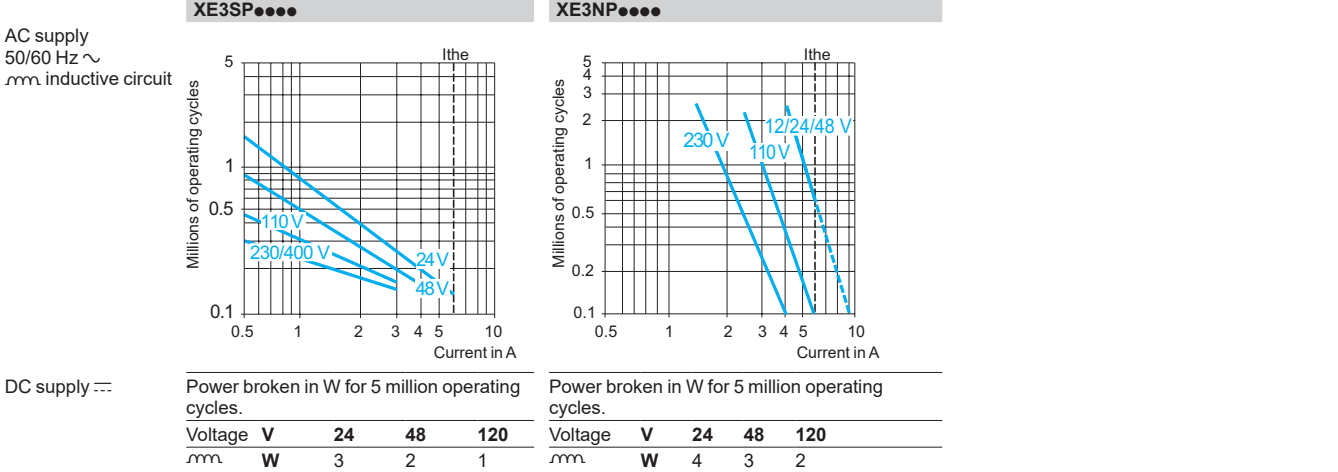

DC supply ---	Power broken in W for 5 million operating cycles.								
	Voltage	V	24	48	120	V	24	48	120
	mm	W	3	2	1	W	4	3	2











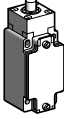
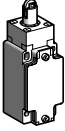

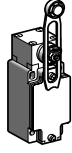

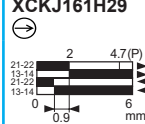
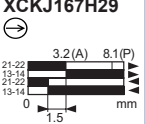
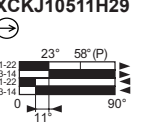
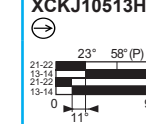
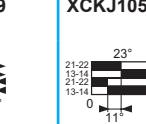

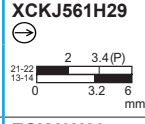
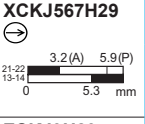
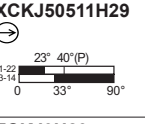
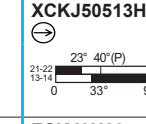
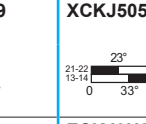
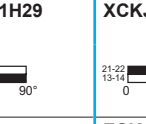

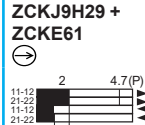
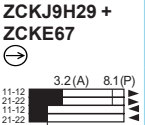
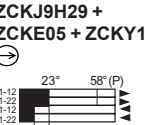
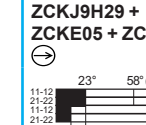



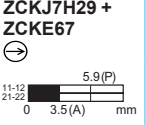
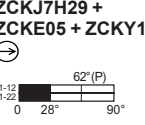
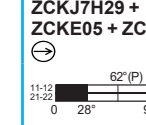

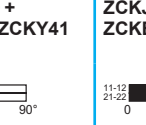



Limit switches

XC Standard range

Industrial format EN 50041

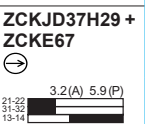
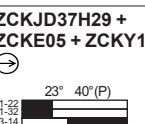
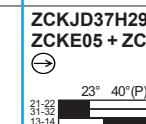
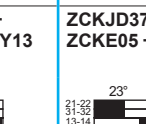
Metal, conforming to CENELEC EN 50041, XCKJ

Complete fixed body switches with 1 cable entry

Type of head	Plunger (fixing by the body)		Rotary (fixing by the body) (switches supplied for actuation from left AND right)				
	Form B (1)	Form C (1)	Form A (1)			Form D (1)	
							
Type of operator	Metal end plunger	Steel roller plunger	Thermoplastic roller lever (2)	Steel roller lever (2)	Variable length thermoplastic roller lever (2)	Round thermoplastic rod lever, Ø 6 mm (2) (4)	
References of complete switches with 1 ISO M20 x 1.5 cable entry(3)							
	2-pole NC + NO snap action (XE2SP2151)	XCKJ161H29 	XCKJ167H29 	XCKJ10511H29 	XCKJ10513H29 	XCKJ10541H29 	XCKJ10559H29 
	2-pole NC + NO break before make, slow break (XE2NP2151)	XCKJ561H29 	XCKJ567H29 	XCKJ50511H29 	XCKJ50513H29 	XCKJ50541H29 	XCKJ50559H29 
	2-pole NC + NC snap action (XE2SP2141)	ZCKJ9H29 + ZCKE61 	ZCKJ9H29 + ZCKE67 	ZCKJ9H29 + ZCKE05 + ZCKY11 	ZCKJ9H29 + ZCKE05 + ZCKY13 	ZCKJ9H29 + ZCKE05 + ZCKY41 	ZCKJ9H29 + ZCKE05 + ZCKY59 
	2-pole NC + NC simultaneous, slow break (XE2NP2141)	ZCKJ7H29 + ZCKE61 	ZCKJ7H29 + ZCKE67 	ZCKJ7H29 + ZCKE05 + ZCKY11 	ZCKJ7H29 + ZCKE05 + ZCKY13 	ZCKJ7H29 + ZCKE05 + ZCKY41 	ZCKJ7H29 + ZCKE05 + ZCKY59 
	3-pole NC + NC + NO snap action (XE3SP2141)	ZCKJD39H29 + ZCKE61 	ZCKJD39H29 + ZCKE67 	ZCKJD39H29 + ZCKE05 + ZCKY11 	ZCKJD39H29 + ZCKE05 + ZCKY13 	ZCKJD39H29 + ZCKE05 + ZCKY41 	ZCKJD39H29 + ZCKE05 + ZCKY59 
	3-pole NC + NC + NO break before make, slow break (XE3NP2141)	ZCKJD37H29 + ZCKE61 	ZCKJD37H29 + ZCKE67 	ZCKJD37H29 + ZCKE05 + ZCKY11 	ZCKJD37H29 + ZCKE05 + ZCKY13 	ZCKJD37H29 + ZCKE05 + ZCKY41 	ZCKJD37H29 + ZCKE05 + ZCKY59 
Weight (kg)	0.430	0.455	0.480	0.490	0.485	0.485	
Contact operation	 closed  open		(A) = cam displacement (P) = positive opening point			 NC contact with positive opening operation	

References of complete switches with 1 Pg 13.5 cable entry (2)

For complete switches with entry for Pg 13.5 cable gland, delete H29 from the end of the reference. Example: XCKJ161H29 becomes **XCKJ161**.

References of complete switches with 1 entry for 1/2" NPT conduit (2)

For complete switches with entry for 1/2" NPT (USAS B2-1) conduit, replace H29 at the end of the reference by H7. Example: XCKJ161H29 becomes **XCKJ161H7**.

(1) Form conforming to EN 50041, see page 25.

(2) Adjustable throughout 360° in 5° steps, or in 45° steps by reversing the lever or its mounting.

(3) Switches with gold contacts or eyelet type connections: please consult our Customer Care Centre.

(4) Value taken with actuation by moving part at 100 mm from the fixing.

Limit switches

XC Standard range

Industrial format EN 50041

Metal, conforming to CENELEC EN 50041, XCKJ

Complete fixed body switches with 1 cable entry

Characteristics

Switch actuation	On end	By 30° cam			By any moving part
Type of actuation					
Maximum actuation speed	0.5 m/s	1 m/s	1.5 m/s		
Mechanical durability (1) (in millions of operating cycles)	30	25	30		
Minimum force or torque	For tripping	20 N	16 N	0.25 N.m	
	For positive opening	50 N	40 N	0.50 N.m	
Cable entry (3)	1 entry tapped M20 x 1.5 mm for ISO cable gland, clamping capacity 9 to 12 mm				

(1) Limited to 15 million operating cycles for switches with contacts XE3●P.

Dimensions

XCKJ●61H29
ZCKJ● + ZCKE61

XCKJ●67H29
ZCKJ● + ZCKE67

XCKJ●051●H29
ZCKJ● + ZCKE05 + ZCKY11 or Y13

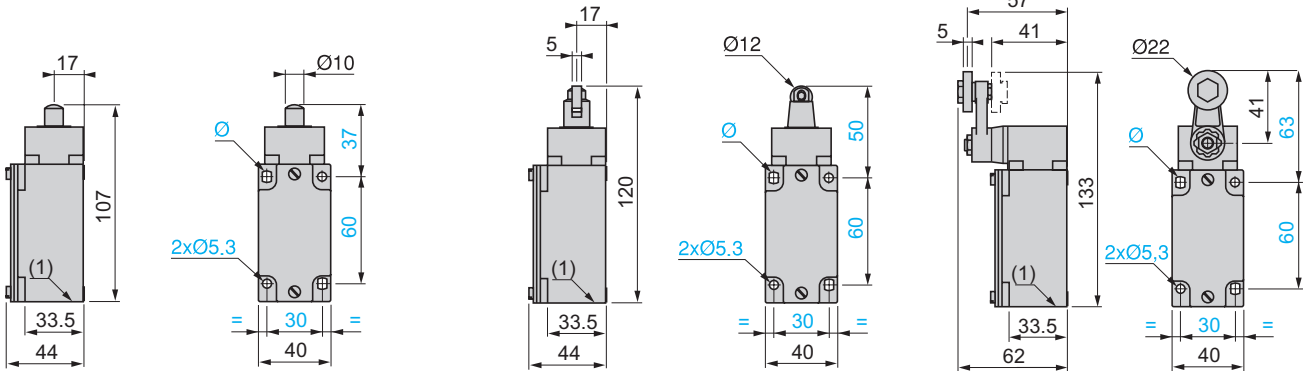

XCKJ●0541H29
ZCKJ● + ZCKE05 + ZCKY41

XCKJ●0559H29
ZCKJ● + ZCKE05 + ZCKY59

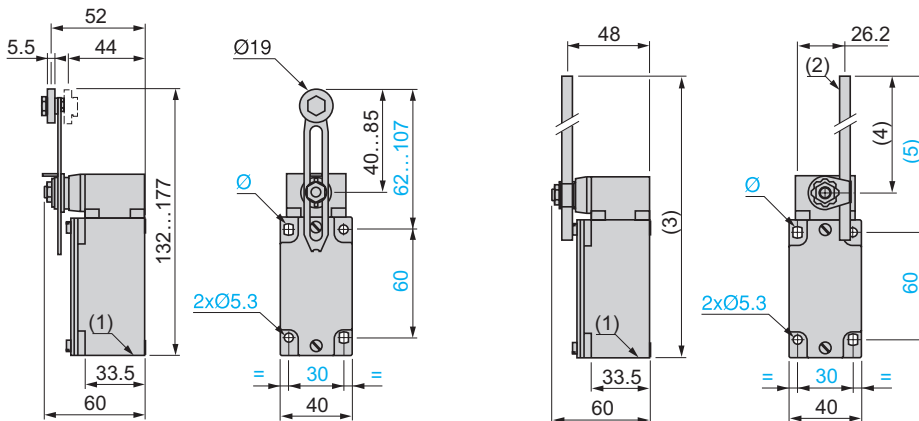

(1) 1 tapped entry for ISO M20 x 1.5 or Pg 13.5 cable gland or tapped 1/2" NPT.

(2) Ø 6 rod, length 200 mm.

(3) 282 max.







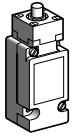
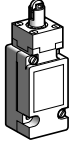

(4) 190 max.

(5) 212 max.

Ø: 2 elongated holes Ø 5.3 x 7.3.

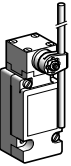
Limit switches

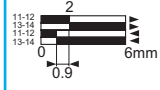
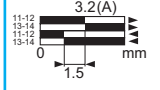
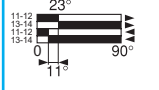
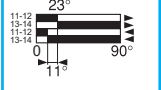
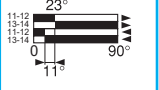
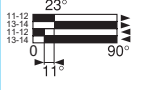
XC Standard range, industrial format EN 50041
Metal, conforming to CENELEC EN 50041, XCKJ
Complete switches, plug-in body
With 1 cable entry

Type of head	Plunger (fixing by the body)		Rotary (fixing by the body) (switches supplied for actuation from left AND right)			
	Form B (1)	Form C (1)	Form A (1)		Form D (1)	
						
Type of operator	Metal end plunger	Steel roller plunger	Thermoplastic roller lever (2)	Steel roller lever (2)	Variable length thermoplastic roller lever (2)	Round thermoplastic rod lever, Ø 6 mm (2) (4)
References of complete switches with 1 ISO M20 x 1.5 cable entry (3)						
 Single-pole CO snap action	XCKJ1161H29	XCKJ1167H29	XCKJ110511H29	XCKJ110513H29	XCKJ110541H29	XCKJ110559H29
						
Weight (kg)	0.430	0.455	0.480	0.490	0.485	0.485
Contact operation	 closed  open		(A) = cam displacement			



References of complete switches with 1 Pg 13.5 cable entry (3)

For complete switches with entry for Pg 13.5 cable gland, delete **H29** from the end of the reference.
Example: **XCKJ1161H29** becomes **XCKJ1161**.

References of complete switches with 1 entry for 1/2" NPT conduit (3)

For complete switches with entry for 1/2" NPT (USAS B2-1) conduit, replace **H29** at the end of the reference by **H7**.
Example: **XCKJ1161H29** becomes **XCKJ1161H7**.

Characteristics

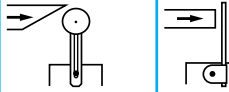
Switch actuation	On end	By 30° cam	By any moving part
Type of actuation			
Maximum actuation speed	0.5 m/s	1 m/s	1.5 m/s
Mechanical durability (in millions of operating cycles)	30	25	30
Minimum tripping force or torque	20 N	16 N	0.25 N.m
Cable entry	1 entry tapped M20 x 1.5 for ISO cable gland Clamping capacity 7 to 13 mm		

(1) Form conforming to EN 50041, see page 25.

(2) Adjustable throughout 360° in 5° steps, or in 45° steps by reversing the lever or its mounting.

(3) Switches with gold contacts: please consult our Customer Care Centre.

(4) Value taken with actuation by moving part at 100 mm from the fixing.

Limit switches

XC Standard range, industrial format EN 50041

Metal, conforming to CENELEC EN 50041, XCKJ

Complete switches, plug-in body

With 1 cable entry

XCKJ1161H29

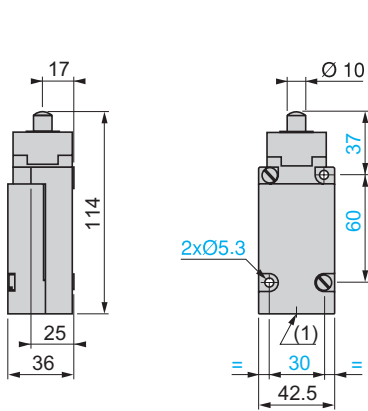

XCKJ1167H29

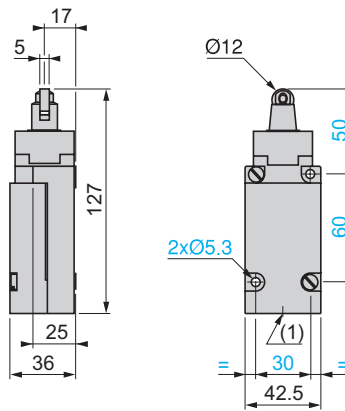

XCKJ110511H29, XCKJ110513H29

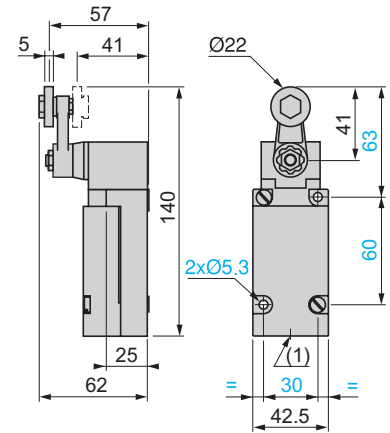

XCKJ110541H29

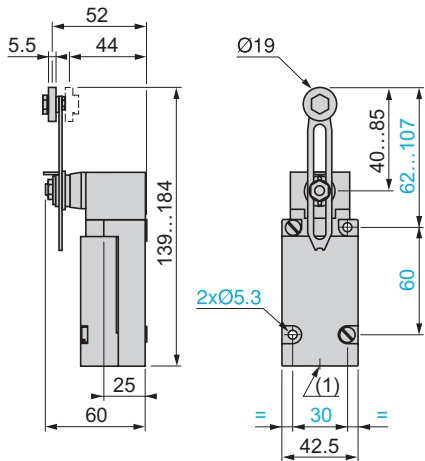

XCKJ110559H29

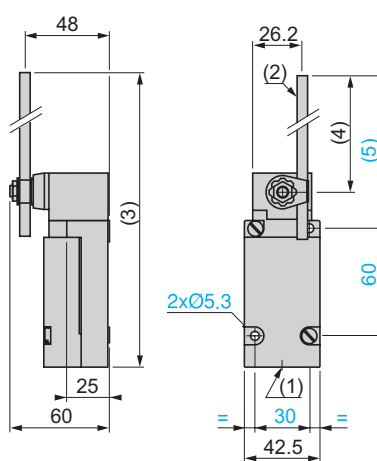

(1) 1 tapped entry for ISO M20 x 1.5 or Pg 13.5 cable gland or for 1/2" NPT conduit.

(2) $\varnothing 6$ rod, length 200 mm.



(3) 289 max.



(4) 190 max.



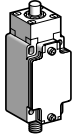
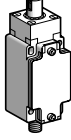
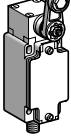
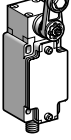

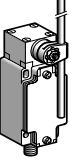
(5) 212 max.

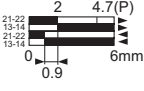
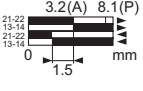
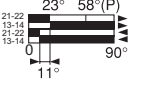
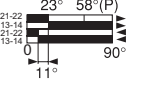
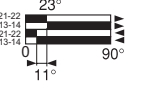
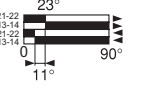
Limit switches

XC Standard range, industrial format EN 50041
Metal, conforming to CENELEC EN 50041, XCKJ
Complete switches, fixed body
M12 connector

Type of head	Plunger (fixing by the body)		Rotary (fixing by the body) (switches supplied for actuation from left AND right)			
	Form B (1)	Form C (1)	Form A (1)		Form D (1)	
						
Type of operator	Metal end plunger	Steel roller plunger	Thermoplastic roller lever (2)	Steel roller lever (2)	Variable length thermoplastic roller lever (2)	Round thermoplastic rod lever, Ø 6 mm (2) (3)

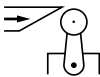
References (4)	2-pole NC + NO snap action (XE2SP2151)					
	XCKJ161D	XCKJ167D	XCKJ10511D	XCKJ10513D	XCKJ10541D	XCKJ10559D
						
Weight (kg)	0.430	0.455	0.480	0.490	0.485	0.485
Contact operation	 closed  open		(A) = cam displacement (P) = positive opening point			

Characteristics				
Switch actuation	On end	By 30° cam		By any moving part
Type of actuation				
Maximum actuation speed	0.5 m/s	1 m/s	1.5 m/s	
Mechanical durability (in millions of operating cycles)	30	25	30	
Minimum force or torque	For tripping	20 N	16 N	0.25 N.m
	For positive opening	50 N	40 N	0.50 N.m
Connection	M12 connector, U _i = 60 V, I _e = 4 A (see suitable pre-wired female connectors below).			

- (1) Form conforming to EN 50041, see page 25.
- (2) Adjustable throughout 360° in 5° steps, or in 45° steps by reversing the lever or its mounting.
- (3) Value taken with actuation by moving part at 100 mm from the fixing.
- (4) Switches with gold contacts: please consult our Customer Care Centre.

References of suitable pre-wired female connectors		
Type of connector	M12 straight, 5-pin, 4 A/24 V max.	M12 elbowed, 5-pin, 4 A/24 V max.
With cable, Ø 5.8 mm (4 x 0.34 mm ² + 1 x 0.5 mm ²)	L = 2 m	XZCP1164L2
	L = 5 m	XZCP1164L5
	L = 10 m	XZCP1164L10
Weight (kg)	L = 2 m	0.115
	L = 5 m	0.270
	L = 10 m	0.520

Limit switches

XC Standard range, industrial format EN 50041
Metal, conforming to CENELEC EN 50041, XCKJ
Complete switches, fixed body
M12 connector

Dimensions

XCKJ161D

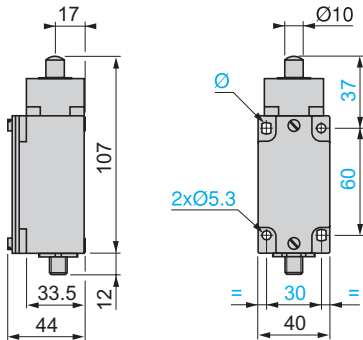

XCKJ167D

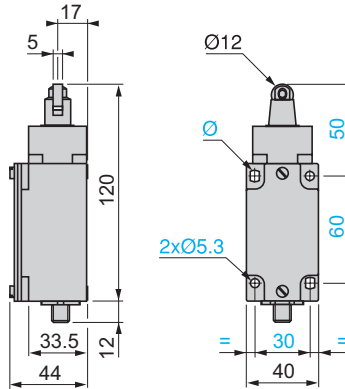

XCKJ1051D

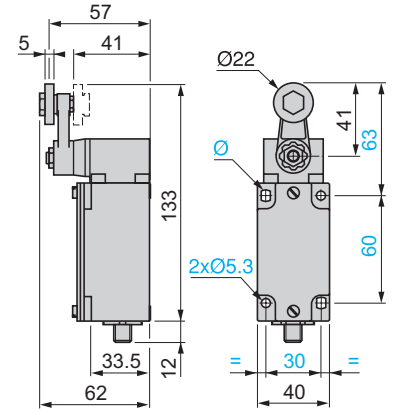

XCKJ10541D

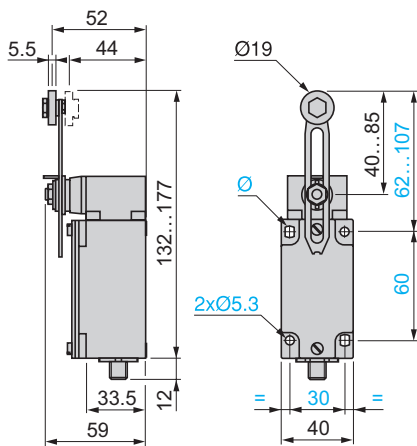

XCKJ10559D

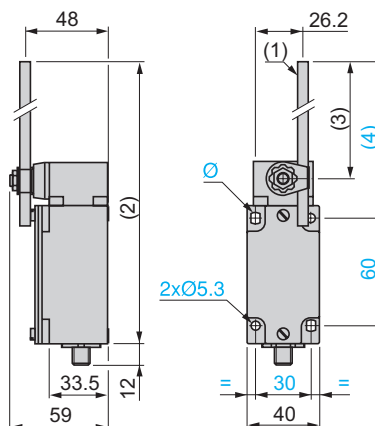

XZCP1164L

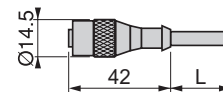

XZCP1264L

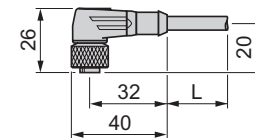

- (1) Ø 6 rod, length 200 mm.
- (2) 282 max.
- (3) 190 max.
- (4) 212 max.
- Ø: 2 elongated holes Ø 5.3 x 7.3.
- L: Cable length 2, 5 or 10 m.

Connections

Limit switch XCKJ●●●●D

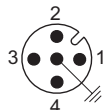

- 1-2 = NC
- 3-4 = NO
- 5 = \perp
- 4 A / 24 V max.

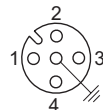

Pre-wired female connector XZCP1●64L







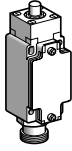
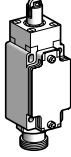
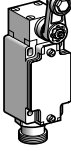
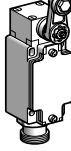

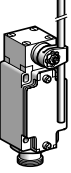

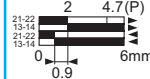
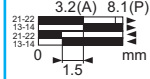
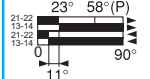
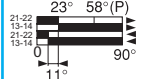
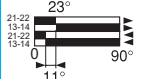
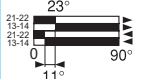
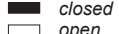
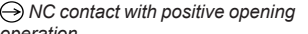
- 1 = brown
- 2 = white
- 3 = blue
- 4 = black
- 5 = \perp yellow/green

Limit switches

XC Standard range, industrial format EN 50041
Metal, conforming to CENELEC EN 50041, XCKJ
Complete switches, fixed body
7/8"-16UN connector

Type of head	Plunger (fixing by the body)		Rotary (fixing by the body) (switches supplied for actuation from left AND right)			
	Form B (1)	Form C (1)	Form A (1)		Form D (1)	
						
Type of operator	Metal end plunger	Steel roller plunger	Thermoplastic roller lever (2)	Steel roller lever (2)	Variable length thermoplastic roller lever (2)	Round thermoplastic rod lever, Ø 6 mm (2) (3)

References (4)	2-pole NC + NO snap action (XE2SP2151)					
	XCKJ161A	XCKJ167A	XCKJ10511A	XCKJ10513A	XCKJ10541A	XCKJ10559A
						
Weight (kg)	0.430	0.455	0.480	0.490	0.485	0.485
Contact operation			(A) = cam displacement (P) = positive opening point			

Characteristics		On end			By 30° cam		By any moving part	
Switch actuation		On end			By 30° cam		By any moving part	
Type of actuation								
Maximum actuation speed		0.5 m/s			1 m/s		1.5 m/s	
Mechanical durability (in millions of operating cycles)		30			25		30	
Minimum force or torque	For tripping	20 N			16 N		0.25 N.m	
	For positive opening	50 N			40 N		0.50 N.m	
Connection		7/8"-16UN connector, Ui = 250 V; Ie = 6 A (see suitable pre-wired female connectors below).						

(1) Form conforming to EN 50041, see page 25.
(2) Adjustable throughout 360° in 5° steps, or in 45° steps by reversing the lever or its mounting.
(3) Value taken with actuation by moving part at 100 mm from the fixing.
(4) Switches with gold contacts: please consult our Customer Care Centre.

References of suitable pre-wired female connectors		
Type of connector	7/8"-16UN straight, 5-pin, 4 A/250 V max.	
With cable, Ø 5.9 mm (5 x 0.34 mm ²)	L = 2 m	XZCP1764L2
	L = 5 m	XZCP1764L5
	L = 10 m	XZCP1764L10
Weight (kg)	L = 2 m	0.185
	L = 5 m	0.460
	L = 10 m	0.900

Limit switches

XC Standard range, industrial format EN 50041
Metal, conforming to CENELEC EN 50041, XCKJ
Complete switches, fixed body
7/8"-16UN connector

Dimensions

XCKJ161A

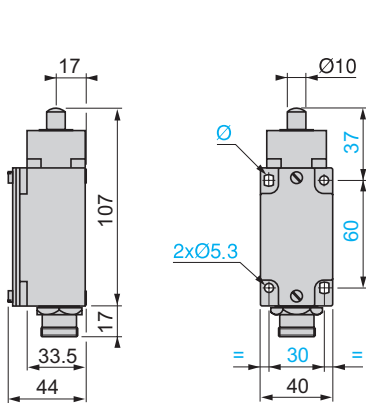

XCKJ167A

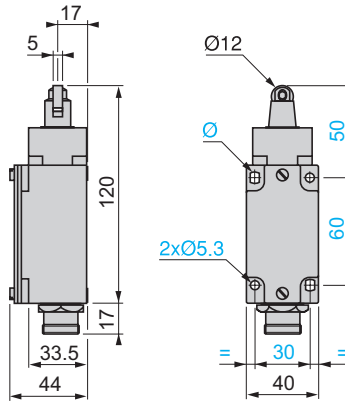

XCKJ1051●A

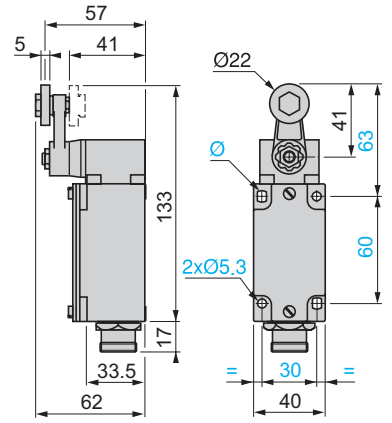

XCKJ10541A

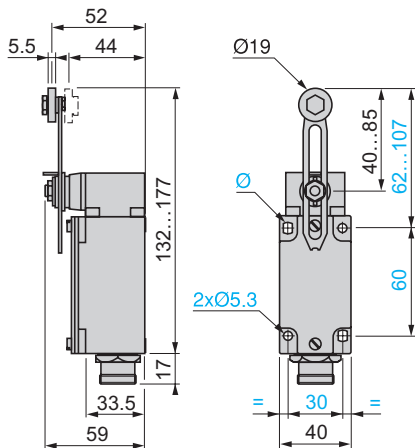

XCKJ10559A

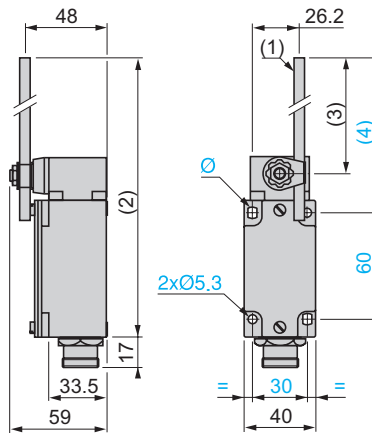

XZCP1764●

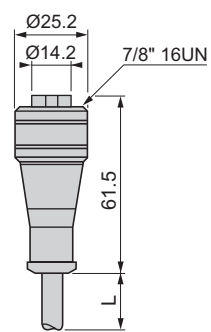

- (1) Ø 6 rod, length 200 mm.
- (2) 282 max.
- (3) 190 max.
- (4) 212 max.
- Ø: 2 elongated holes Ø 5.3 x 7.3.
- L: Cable length 2, 5 or 10 m.

Connections

Limit switch XCKJ●●●●A

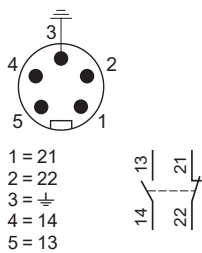

Pre-wired female connector XZCP1764●

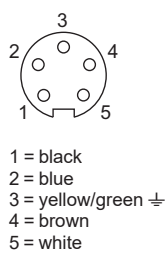

Limit switches

XC Standard range, industrial format EN 50041
 Metal, conforming to CENELEC EN 50041, XCKJ
 Fixed or plug-in body
 Variable composition: standard bodies

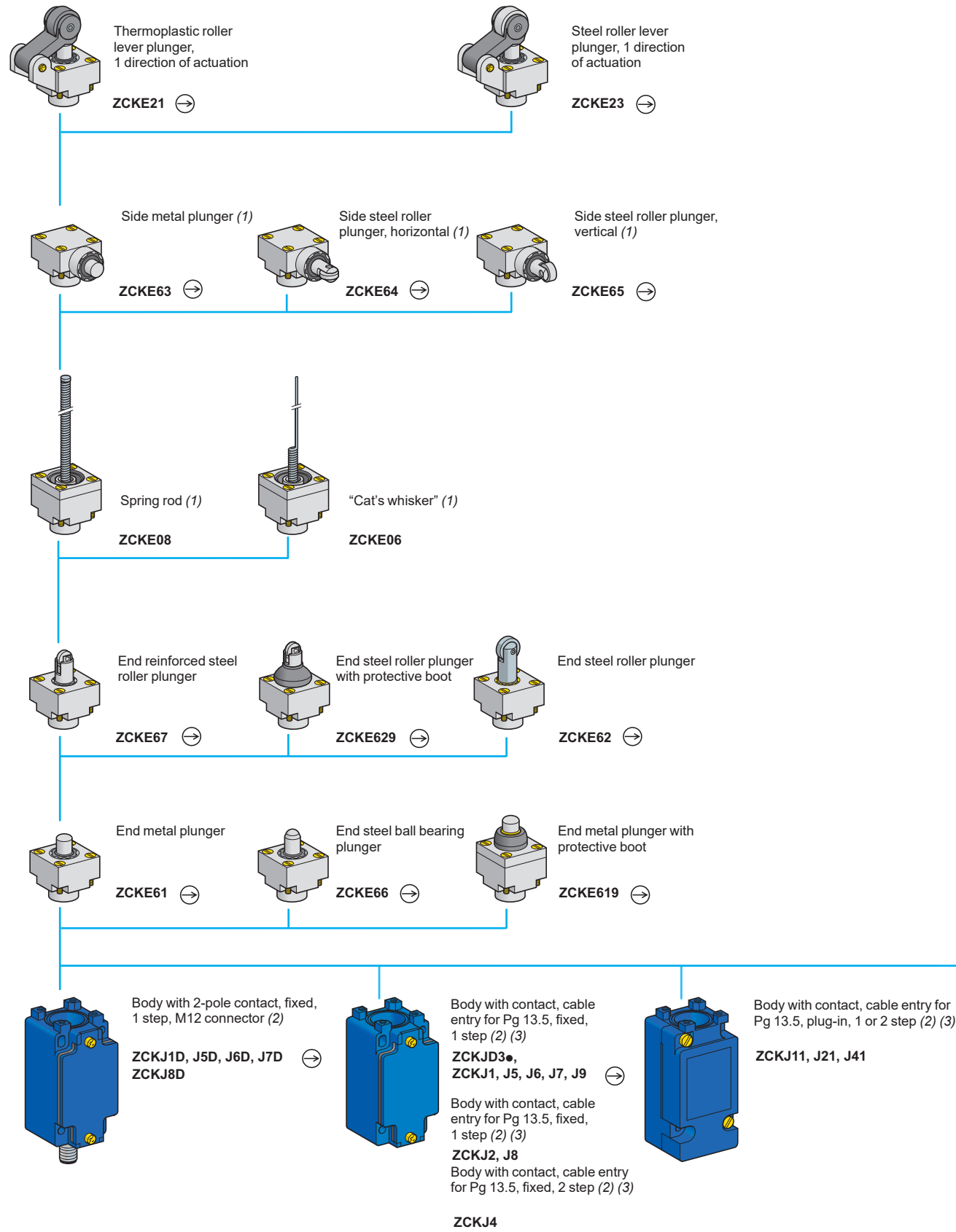

(1) Cannot be used with bodies ZCKJ4 and ZCKJ41.
 (2) For further information, see page 159.
 (3) For a cable entry tapped ISO M20 x 1.5, add H29 to the reference. Example: ZCKJ1 becomes ZCKJ1H29.
 For a cable entry tapped 1/2" NPT, add H7 to the reference. Example: ZCKJ1 becomes ZCKJ1H7.

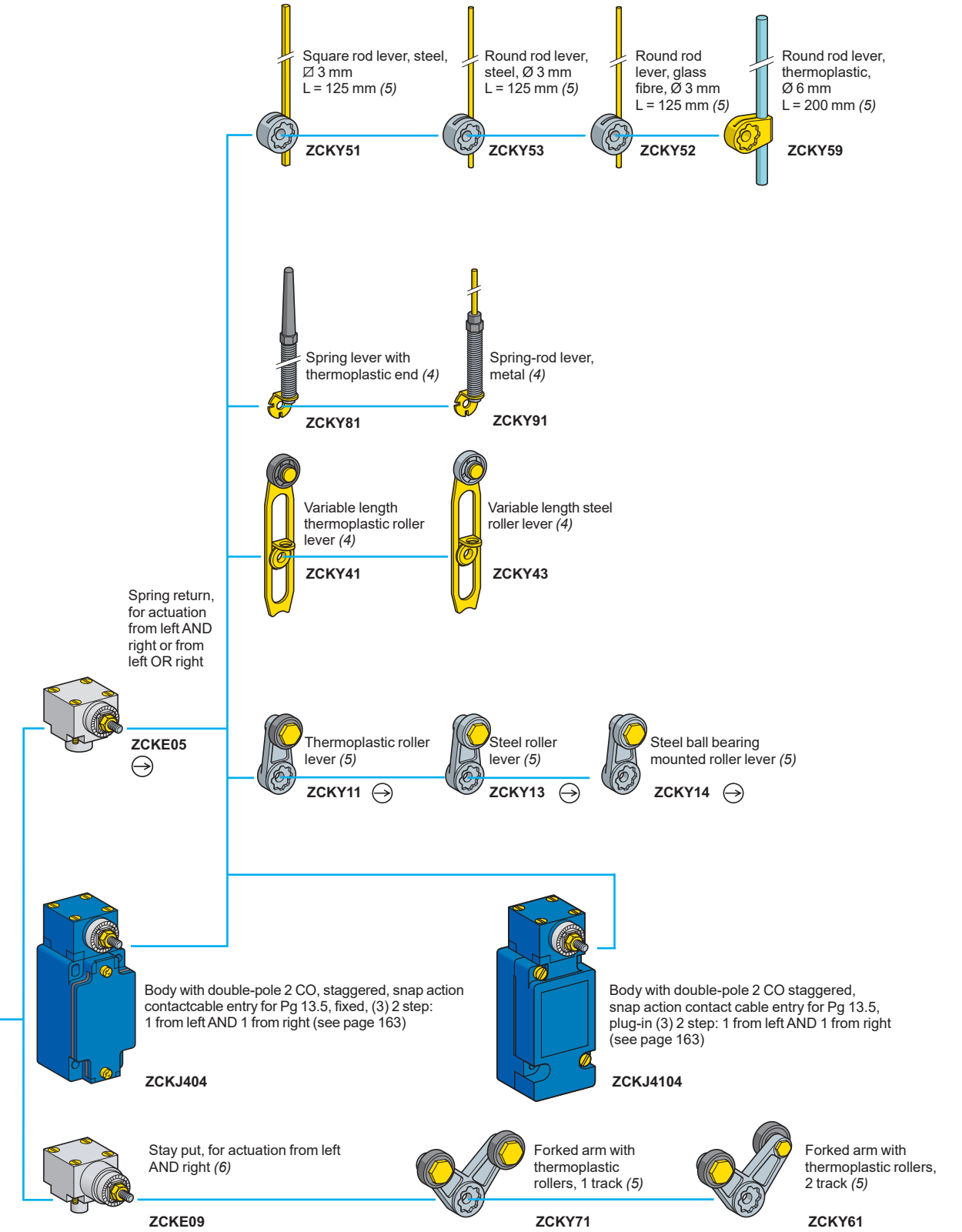

⊙ : head assuring positive opening operation.

(4) Adjustable throughout 360° in 5° steps, or in 90° steps by reversing the notched washer.
 (5) Adjustable throughout 360° in 5° steps, or in 45° steps by reversing the lever mounting.
 (6) Suitable for bodies with contacts ZCKJ1, J2, J31, J39.

Limit switches

XC Standard range, industrial format EN 50041

Metal, conforming to CENELEC EN 50041, XCKJ

Fixed or plug-in body

Adaptable sub-assemblies: standard bodies

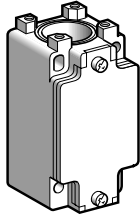

ZCKJ●

Fixed bodies with 2-pole contact

Type	With contact block	Scheme	Positive operation (1)	Cable entry	Reference	Weight kg
1 step	1 NC + 1 NO snap action (XE2SP2151)		⊖	Pg 13.5	ZCKJ1	0.310
				ISO M20 x 1.5	ZCKJ1H29	0.310
				1/2" NPT	ZCKJ1H7	0.310
	2 CO simultaneous, snap action (XE2SP2021)		-	Pg 13.5	ZCKJ2	0.310
				ISO M20 x 1.5	ZCKJ2H29	0.310
				1/2" NPT	ZCKJ2H7	0.310
	1 NC + 1 NO break before make, slow break (XE2NP2151)		⊖	Pg 13.5	ZCKJ5	0.310
				ISO M20 x 1.5	ZCKJ5H29	0.310
				1/2" NPT	ZCKJ5H7	0.310
1 NO + 1 NC make before break, slow break (XE2NP2161)		⊖	Pg 13.5	ZCKJ6	0.310	
			ISO M20 x 1.5	ZCKJ6H29	0.310	
			1/2" NPT	ZCKJ6H7	0.310	
2 NC simultaneous, slow break (XE2NP2141)		⊖	Pg 13.5	ZCKJ7	0.310	
			ISO M20 x 1.5	ZCKJ7H29	0.310	
			1/2" NPT	ZCKJ7H7	0.310	
2 NO simultaneous, slow break (XE2NP2131)		-	Pg 13.5	ZCKJ8	0.310	
			ISO M20 x 1.5	ZCKJ8H29	0.310	
			1/2" NPT	ZCKJ8H7	0.310	
2 NC snap action (XE2SP2141)		⊖	Pg 13.5	ZCKJ9	0.310	
			ISO M20 x 1.5	ZCKJ9H29	0.310	
			1/2" NPT	ZCKJ9H7	0.310	
2 step	2 CO staggered snap action (XE2SP2031)		-	Pg 13.5	ZCKJ4	0.310
				ISO M20 x 1.5	ZCKJ4H29	0.310
				1/2" NPT	ZCKJ4H7	0.310

Fixed bodies with 3-pole contact

Type	With contact block	Scheme	Positive operation (1)	Cable entry	Reference	Weight kg
-	1 NC + 2 NO snap action (XE3SP2151)		⊖	Pg 13.5	ZCKJD31	0.310
				ISO M20 x 1.5	ZCKJD31H29	0.310
				1/2" NPT	ZCKJD31H7	0.310
				2 NC + 1 NO snap action (XE3SP2141)		⊖
ISO M20 x 1.5	ZCKJD39H29	0.310				
1/2" NPT	ZCKJD39H7	0.310				
2 NC + 1 NO break before make, slow break (XE3NP2141)		⊖	Pg 13.5	ZCKJD37	0.310	
			ISO M20 x 1.5	ZCKJD37H29	0.310	
			1/2" NPT	ZCKJD37H7	0.310	
1 NC + 2 NO break before make, slow break (XE3NP2151)		⊖	Pg 13.5	ZCKJD35	0.310	
			ISO M20 x 1.5	ZCKJD35H29	0.310	
			1/2" NPT	ZCKJD35H7	0.310	

(1) ⊖: NC contact with positive opening operation.

Limit switches

XC Standard range, industrial format EN 50041

Metal, conforming to CENELEC EN 50041, XCKJ

Fixed or plug-in body

Adaptable sub-assemblies: standard bodies

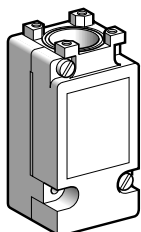

ZCKJ01

Plug-in bodies with contact

Type	With contact block	Scheme	Positive operation (1)	Cable entry	Reference	Weight kg
1 step	Single-pole 1 CO snap action		-	Pg 13.5	ZCKJ11	0.300
				ISO M20 x 1.5	ZCKJ11H29	0.300
				1/2" NPT	ZCKJ11H7	0.300
2 step	Double-pole 2 CO simultaneous, snap action		-	Pg 13.5	ZCKJ21	0.300
				ISO M20 x 1.5	ZCKJ21H29	0.300
				1/2" NPT	ZCKJ21H7	0.300
2 step	Double-pole 2 CO staggered, snap action		-	Pg 13.5	ZCKJ41	0.300
				ISO M20 x 1.5	ZCKJ41H29	0.300
				1/2" NPT	ZCKJ41H7	0.300

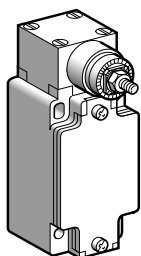

ZCKJ404

Bodies with contact, with rotary head (without operating lever)

Type	With contact block	Scheme	Positive operation (1)	Cable entry	Reference	Weight kg
Fixed body						
2 step 1 from left AND 1 from right (see page 163)	Double-pole 2 CO staggered, snap action		-	Pg 13.5	ZCKJ404	0.455
				ISO M20 x 1.5	ZCKJ404H29	0.455
				1/2" NPT	ZCKJ404H7	0.455
Plug-in body						
2 step 1 from left AND 1 from right (see page 163)	Double-pole 2 CO staggered, snap action		-	Pg 13.5	ZCKJ4104	0.465
				ISO M20 x 1.5	ZCKJ4104H29	0.465
				1/2" NPT	ZCKJ4104H7	0.465

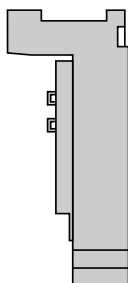

ZCKJ00

Plug-in housing only

Description	For use with	Contacts	Reference	Weight kg
Single-pole 1 CO with positive opening operation	ZCKJ11	Silver	ZCKJ01	0.150
Double-pole 2 CO with positive opening operation	ZCKJ21	Silver	ZCKJ02	0.160
Double-pole 2 CO staggered	ZCKJ41	Silver	ZCKJ04	0.160

(1) ⊖: NC contact with positive opening operation.

Limit switches

XC Standard range, industrial format EN 50041
Metal, conforming to CENELEC EN 50041, XCKJ
Fixed or plug-in body. Adaptable sub-assemblies:
bodies with indicator light module

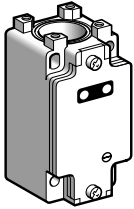

ZCKJ●●●

Fixed bodies with 2-pole contact

Type	With contact block	Scheme	Positive operation (1)	Cable entry	Reference	Weight kg
With module comprising 1 LED, 24 V $\overline{\text{---}}$						
1 step	1 NC + 1 NO snap action (XE2SP2151)			Pg 13.5	ZCKJ120	0.320
	1 NC + 1 NO break before make, slow break (XE2NP2151)			Pg 13.5	ZCKJ520	0.320
With module comprising 2 LEDs, 24 V $\overline{\text{---}}$						
1 step	1 NC + 1 NO snap action (XE2SP2151)			Pg 13.5 ISO M20 x 1.5	ZCKJ121 ZCKJ121H29	0.320 0.320
	1 NC + 1 NO break before make, slow break (XE2NP2151)			Pg 13.5 ISO M20 x 1.5	ZCKJ521 ZCKJ521H29	0.320 0.320
With module comprising 2 LEDs, 110/240 V \sim						
1 step	1 NC + 1 NO snap action (XE2SP2151)			Pg 13.5 ISO M20 x 1.5	ZCKJ134 ZCKJ134H29	0.320 0.320
	1 NC + 1 NO break before make, slow break (XE2NP2151)			Pg 13.5 ISO M20 x 1.5	ZCKJ534 ZCKJ534H29	0.320 0.320

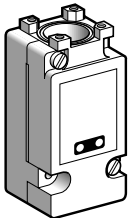

ZCKJ1●●●

Plug-in bodies with single-pole contact

Type	With contact block	Scheme	Positive operation (1)	Cable entry	Reference	Weight kg
With module comprising 2 LEDs, 24 V $\overline{\text{---}}$						
1 step	CO snap action		–	Pg 13.5 ISO M20 x 1.5	ZCKJ1121 ZCKJ1121H29	0.340 0.340
With module comprising 2 LEDs, 110/240 V \sim						
1 step	CO snap action		–	Pg 13.5 ISO M20 x 1.5	ZCKJ1134 ZCKJ1134H29	0.340 0.340

(1) : NC contact with positive opening operation.

Indicator light module characteristics

Type of indicator	1 LED or 2 LEDs	2 LEDs
Rated insulation voltage	50 V $\overline{\text{---}}$, conforming to IEC 60947-1	250 V \sim , conforming to IEC 60947-1
Current consumption	7 mA per LED	9 mA per LED
Rated operational voltage	24 V $\overline{\text{---}}$	110/240 V \sim
Voltage limits	20...30 V $\overline{\text{---}}$ (including ripple)	95...264 V \sim
Service life	100 000 hours	100 000 hours
Reverse polarity protection	Yes	–

Limit switches

XC Standard range, industrial format EN 50041

Metal, conforming to CENELEC EN 50041, XCKJ

Fixed or plug-in body. Adaptable sub-assemblies:
bodies with M12 connector

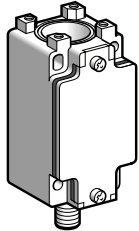

ZCKJ●D

Fixed bodies with 2-pole contact

Type	With contact block	Scheme	Positive operation (1)	Reference	Weight kg
1 step	1 NC + 1 NO snap action (XE2SP2151)			ZCKJ1D	0.320
	1 NC + 1 NO break before make, slow break (XE2NP2151)			ZCKJ5D	0.320
	1 NO + 1 NC make before break, slow break (XE2NP2161)			ZCKJ6D	0.320
	2 NC simultaneous, slow break (XE2NP2141)			ZCKJ7D	0.320
	2 NO simultaneous, slow break (XE2NP2131)		-	ZCKJ8D	0.320

Female pre-wired connectors

Description	Cable length	Reference	Weight kg
Female pre-wired connectors, M12, straight Ø 5,0 mm cable Conductor c.s.a: 5 x 0.34 mm ² Nominal current : 4 A Nominal voltage: ~ 30 V, ~ 36 V	1 m	XZCP1164L2	0.115
	5 m	XZCP1164L5	0.270
	10 m	XZCP1164L10	0.520

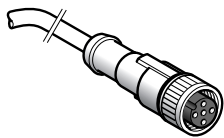

XZCP1164L●

(1) NC contact with positive opening operation.

Limit switches

XC Standard range, industrial format EN 50041

Metal, conforming to CENELEC EN 50041, XCKJ

Fixed or plug-in body

Adaptable sub-assemblies: contact blocks



XE2SP21●1

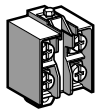

XE2NP21●1

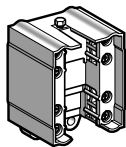

XESP20●1

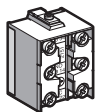

XE3●P21●1

Contact blocks						
Type of contact	Scheme	For bodies	Positive operation (1)	Reference	Weight kg	
2-pole contact						
1 NC + 1 NO snap action		ZCKJ1 ZCKJ1D	⊖	XE2SP2151	0.020	
1 NC + 1 NO break before make, slow break		ZCKJ5 ZCKJ5D	⊖	XE2NP2151	0.020	
2 CO simultaneous snap action		ZCKJ2	-	XESP2021	0.045	
2 CO staggered, snap action		ZCKJ4	-	XESP2031	0.045	
1 NO + 1 NC make before break, slow break		ZCKJ6 ZCKJ6D	⊖	XE2NP2161	0.020	
2 NC simultaneous, slow break		ZCKJ7 ZCKJ7D	⊖	XE2NP2141	0.020	
2 NO simultaneous, slow break		ZCKJ8 ZCKJ8D	-	XE2NP2131	0.020	
2 NC snap action		ZCKJ9	⊖	XE2SP2141	0.020	
3-pole contact						
1 NC + 2 NO snap action		ZCKJD31	⊖	XE3SP2151	0.035	
2 NC + 1 NO snap action		ZCKJD39	⊖	XE3SP2141	0.035	
2 NC + 1 NO break before make, slow break		ZCKJD37	⊖	XE3NP2141	0.035	
1 NC + 2 NO break before make, slow break		ZCKJD35	⊖	XE3NP2151	0.035	

(1) ⊖: NC contact with positive opening operation.

Limit switches

XC Standard range, industrial format EN 50041

Metal, conforming to CENELEC EN 50041, XCKJ

Fixed or plug-in body

Adaptable sub-assemblies: add-ons

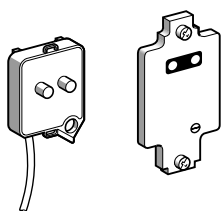

ZCKZ0●●

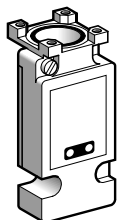

ZCKJ01●●

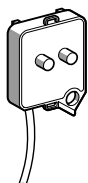

ZCKJ90●

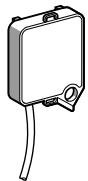

ZCKJ82A

Covers + indicator light module

For use with	Number and type of indicators	Voltage	Reference	Weight kg
Fixed body	1 LED	24 V $\overline{\text{---}}$	ZCKZ020	0.060
	2 LEDs	24 V $\overline{\text{---}}$	ZCKZ021	0.060
	2 LEDs	110/240 V \sim	ZCKZ034	0.060
Plug-in body	2 LEDs	24 V $\overline{\text{---}}$	ZCKJ0121	0.200
	2 LEDs	110/240 V \sim	ZCKJ0134	0.200

Indicator light modules

For use with	Number and type of indicators	Voltage	Reference	Weight kg
Fixed body	1 LED	24 V $\overline{\text{---}}$	ZCKJ902	0.030
	2 LEDs	24 V $\overline{\text{---}}$	ZCKJ906	0.030
	2 LEDs	110/240 V \sim	ZCKJ904	0.030

Module with resistor for machine diagnostics

For use with	Resistor value	Reference	Weight kg
Fixed body (ZCKJ1 only)	15 k Ω , 1/4 W	ZCKJ82A	0.030

Other versions

Covers + indicator light module for other supply voltages.
Please consult our Customer Care Centre.

Limit switches

XC Standard range, industrial format EN 50041
 Metal, conforming to CENELEC EN 50041, XCKJ
 Fixed or plug-in body
 Adaptable sub-assemblies

Function diagrams (positive operation assured only if the associated sub-assemblies are)

Heads ZCKE61, ZCKE619, ZCKE66 with body

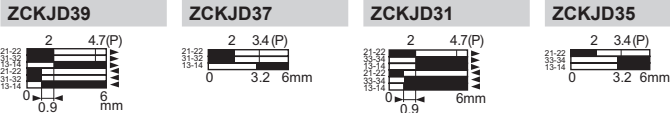

Head ZCKE63 with body

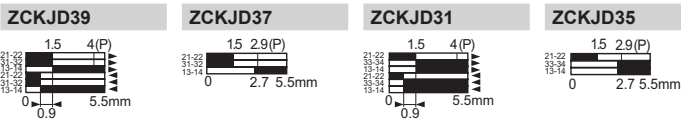
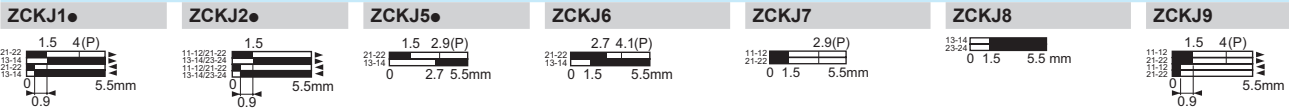

Heads ZCKE64, ZCKE65 with body

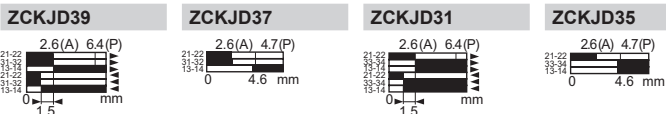
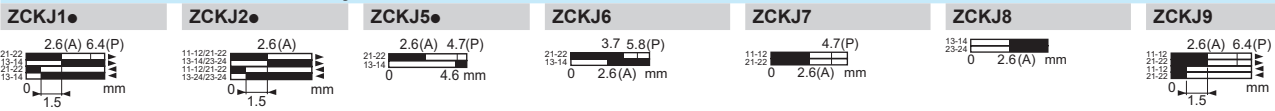

Heads ZCKE67, ZCKE629 with body

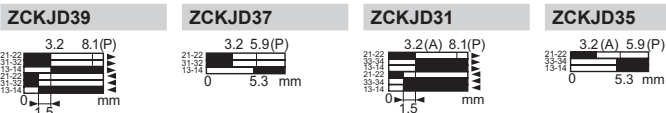
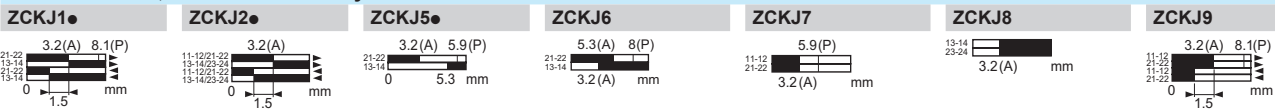

Heads ZCKE21, ZCKE23 with body

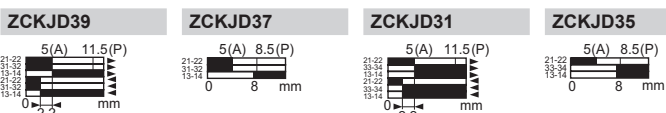
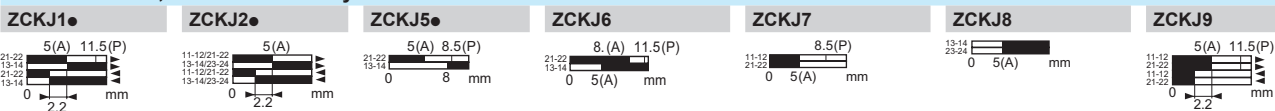

Heads ZCKE06, ZCKE08 with body

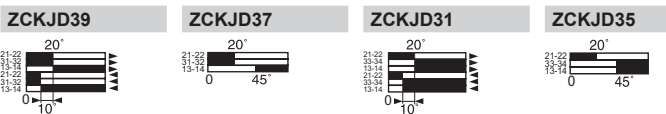
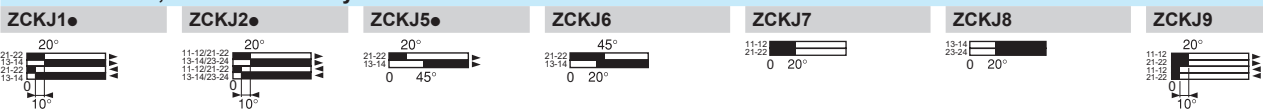

ZCKJ4

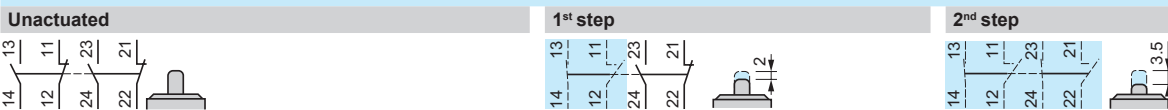

Contact operation

closed
 open

(A) = cam displacement
 (P) = positive opening point

Limit switches

XC Standard range, industrial format EN 50041
Metal, conforming to CENELEC EN 50041, XCKJ
Fixed or plug-in body
Adaptable sub-assemblies

Function diagrams (positive operation assured only if the associated sub-assemblies are)

Head ZCKE05 with body

ZCKJ1●

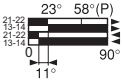

ZCKJ2●

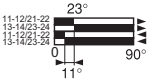

ZCKJ5●

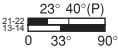

ZCKJ6

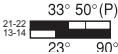

ZCKJ7

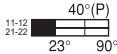

ZCKJ8



ZCKJ9

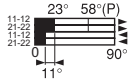

ZCKJD39

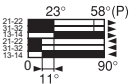

ZCKJD37

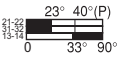

ZCKJD39

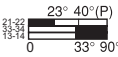

ZCKJD31

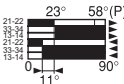

ZCKJ4●

Unactuated

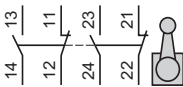

1st step, actuated from left or right

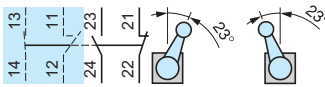

2nd step, actuated from left or right

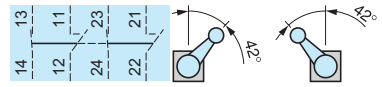

Head ZCKE09 with body

ZCKJ1●

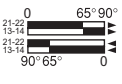

ZCKJ2●

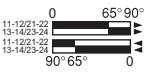

ZCKJD31

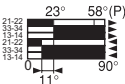

ZCKJD39

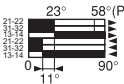

ZCKJ404, J4104 (body with head)

Unactuated

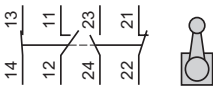

Actuated from left

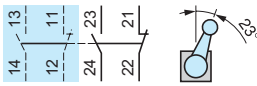

Actuated from right

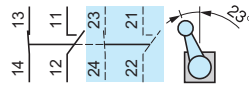

Contact operation

 closed
 open

(P) = positive opening point

Wiring schemes

Indicator light modules

1 LED, 24 V $\overline{\text{DC}}$

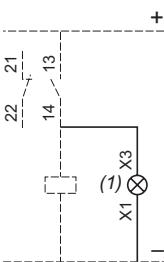

2 LEDs, 24 V $\overline{\text{DC}}$

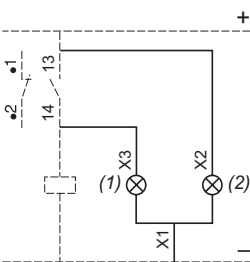

2 LEDs, 110/240 V \sim

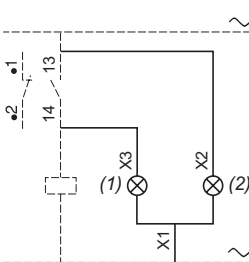

Module with resistor

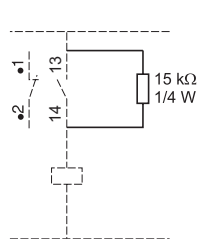

(1) Orange indicator
(2) Green indicator

ZCKJ●D

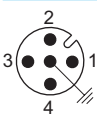

1 - 2 = NC
3 - 4 = NO
5 = \perp
4 A / 24 V max.



Pre-wired connectors XZCP1164●

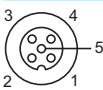

1 = brown
2 = white/black
3 = blue
4 = black
5 = yellow/green

Limit switches

XC Standard range, industrial format EN 50041
 Metal, conforming to CENELEC EN 50041, XCKJ
 Fixed or plug-in body
 Adaptable sub-assemblies

Bodies

ZCKJ1, J2, J5, J4, J●2●, J●3●, J6, J7, J8, J9
 ZCKJ1H29, J2H29, J5H29, J4H29, J●2●H29, J●3●H29,
 J6H29, J7H29, J8H29, J9H29
 ZCKJ1H7, J2H7, J5H7, J4H7, J●2●H7, J●3●H7, J6H7,
 J7H7, J8H7, J9H7

ZCKJ11, J21, J41, J11●●
 ZCKJ11H29, J21H29, J41H29, J11●●H29
 ZCKJ11H7, J21H7, J41H7, J11●●H7

ZCKJ1D, J5D, J6D, J7D, J8D

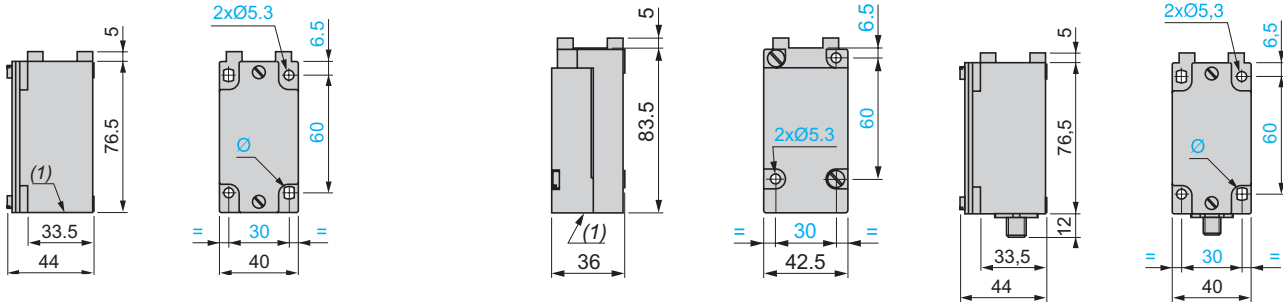

Bodies with rotary head mounted

ZCKJ404, ZCKJ404H29, ZCKJ404H7

ZCKJ4104, ZCKJ4104H29, ZCKJ4104H7

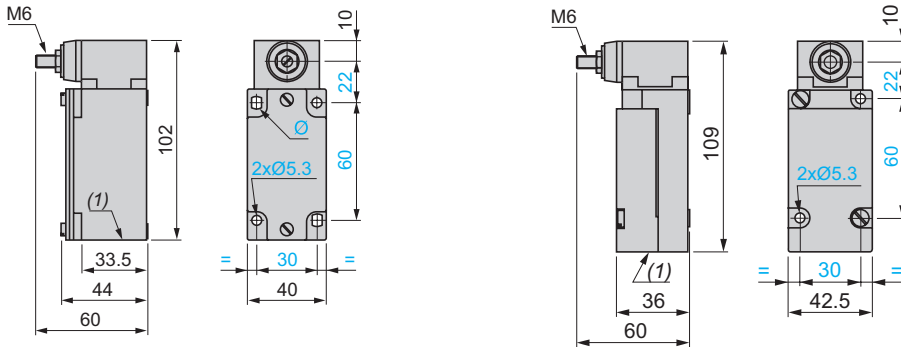

Plunger heads

ZCKE61

ZCKE619

ZCKE63

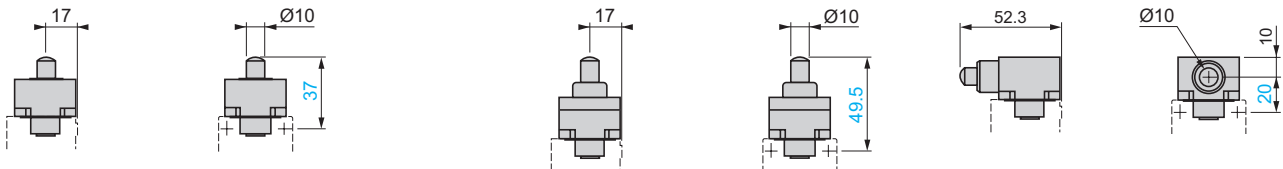

ZCKE64

ZCKE65

ZCKE66

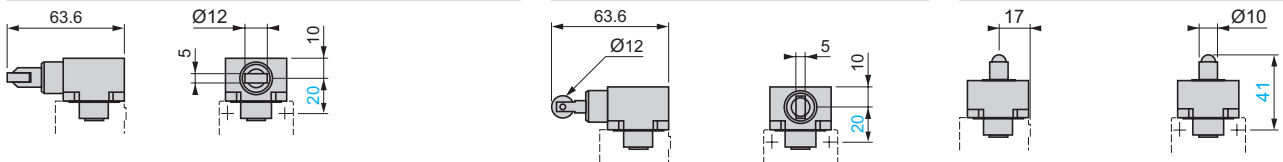

ZCKE62, ZCKE67

ZCKE629

ZCKE21, ZCKE23

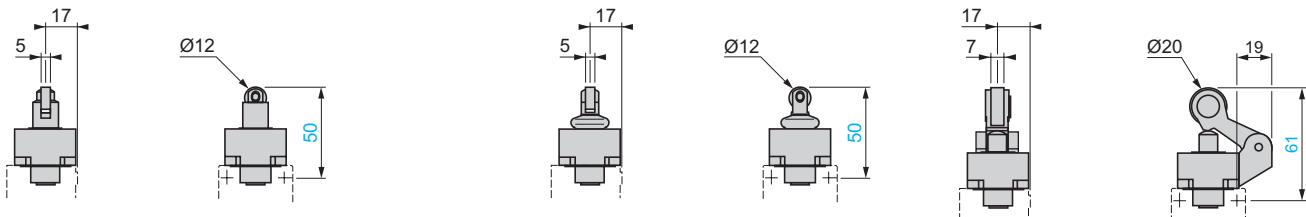

(1) 1 tapped entry for ISO M20 x 1.5 or Pg 13.5 cable gland or tapped 1/2" NPT.
 Ø: 2 elongated holes Ø 5.3 x 7.3.

Limit switches

XC Standard range, industrial format EN 50041
 Metal, conforming to CENELEC EN 50041, XCKJ
 Fixed or plug-in body
 Adaptable sub-assemblies

Rotary head ZCKE05 with operating lever

ZCKY11, ZCKY13, ZCKY14

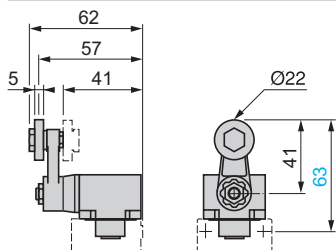

ZCKY41, ZCKY43

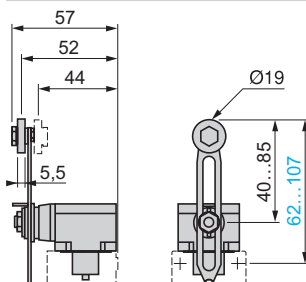

ZCKY51, ZCKY52, ZCKY53, ZCKY59

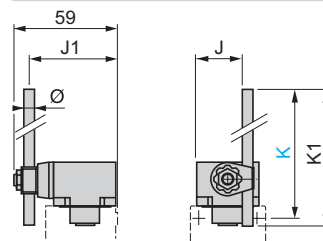

	J	J1	K max.	K1	Ø
ZCKY51	20	49	137	123	∅ 3
ZCKY52	20	49	137	125	∅ 3
ZCKY53	20	49	137	125	∅ 3
ZCKY59	26.2	48	212	200	∅ 6

ZCKY81

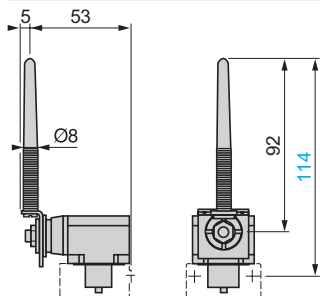

ZCKY91

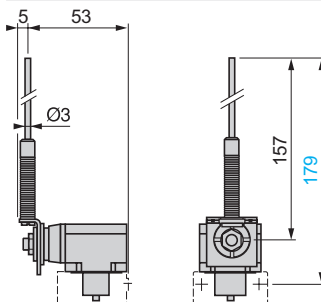

Rotary head ZCKE09 with operating lever

ZCKY61

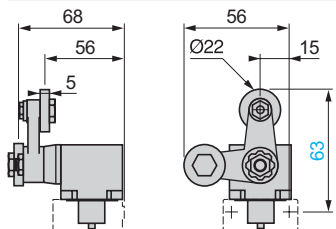

ZCKY71

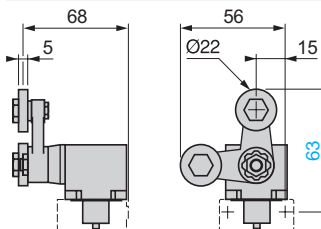

Multi-directional heads

ZCKE06

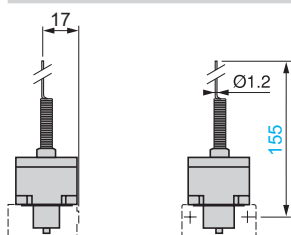

ZCKE08

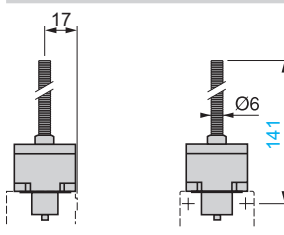

Note: operating lever spindle threaded M6.

Pre-wired connectors XZCP1164L

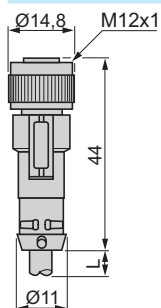

L = 2, 5 or 10 m.

Limit switches

XC Standard range, industrial format EN 50041

Metal, conforming to CENELEC EN 50041, XCKJ

Fixed or plug-in body

Adaptable sub-assemblies for low temperature applications (- 40°C)

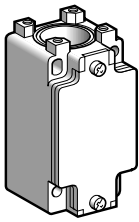

ZCKJ1

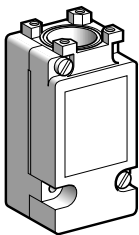

ZCKJ11

Bodies with contacts for plunger or rotary head						
Type	With contact block	Scheme	Positive operation (1)	Cable entry	Reference	Weight kg
Fixed bodies						
1 step	2-pole NC + NO snap action (XE2SP2151)		⊕	Pg 13.5	ZCKJ1	0.310
				ISO M20 x 1.5	ZCKJ1H29	0.310
				1/2" NPT	ZCKJ1H7	0.310
	Double-pole 2 CO simultaneous, snap action (XESP2021)		-	Pg 13.5	ZCKJ2	0.310
				ISO M20 x 1.5	ZCKJ2H29	0.310
				1/2" NPT	ZCKJ2H7	0.310
	2-pole NC + NO break before make, slow break (XE2NP2151)		⊕	Pg 13.5	ZCKJ5	0.310
ISO M20 x 1.5				ZCKJ5H29	0.310	
1/2" NPT				ZCKJ5H7	0.310	
2-pole NO + NC make before break, slow break (XE2NP2161)		⊕	Pg 13.5	ZCKJ6	0.310	
			ISO M20 x 1.5	ZCKJ6H29	0.310	
			1/2" NPT	ZCKJ6H7	0.310	
2-pole NC + NC simultaneous, slow break (XE2NP2141)		⊕	Pg 13.5	ZCKJ7	0.310	
			ISO M20 x 1.5	ZCKJ7H29	0.310	
			1/2" NPT	ZCKJ7H7	0.310	
2-pole NO + NO simultaneous, slow break (XE2NP2131)		-	Pg 13.5	ZCKJ8	0.310	
			ISO M20 x 1.5	ZCKJ8H29	0.310	
			1/2" NPT	ZCKJ8H7	0.310	
2-pole NC + NC snap action (XE2SP2141)		⊕	Pg 13.5	ZCKJ9	0.310	
			ISO M20 x 1.5	ZCKJ9H29	0.310	
			1/2" NPT	ZCKJ9H7	0.310	
2 step	Double-pole 2 CO staggered, snap action (XESP2031)		-	Pg 13.5	ZCKJ4	0.310
				ISO M20 x 1.5	ZCKJ4H29	0.310
				1/2" NPT	ZCKJ4H7	0.310
Plug-in bodies						
1 step	Single-pole CO snap action		-	Pg 13.5	ZCKJ11	0.300
				ISO M20 x 1.5	ZCKJ11H29	0.300
				1/2" NPT	ZCKJ11H7	0.300
Double-pole 2 CO simultaneous snap action		-	Pg 13.5	ZCKJ21	0.300	
			ISO M20 x 1.5	ZCKJ21H29	0.300	
			1/2" NPT	ZCKJ21H7	0.300	
2 step	Double-pole 2 CO staggered, snap action		-	Pg 13.5	ZCKJ41	0.300
				ISO M20 x 1.5	ZCKJ41H29	0.300
				1/2" NPT	ZCKJ41H7	0.300
Bodies with contacts With spring return rotary head (without operating lever)						
Type	With contact block	Scheme	Positive operation (1)	Cable entry	Reference	Weight kg
Fixed body						
2 step 1 from the left AND 1 from the right	Double-pole 2 CO staggered, snap action		-	Pg 13.5	ZCKJ4046	0.455
				ISO M20 x 1.5	ZCKJ4046H29	0.455
				1/2" NPT	ZCKJ4046H7	0.455
Plug-in body						
2 step 1 from the left AND 1 from the right	Double-pole 2 CO staggered, snap action		-	Pg 13.5	ZCKJ41046	0.465
				ISO M20 x 1.5	ZCKJ41046H29	0.465
				1/2" NPT	ZCKJ41046H7	0.465

(1) ⊕: head assuring positive opening operation.

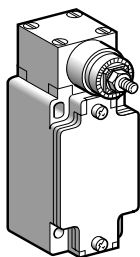

ZCKJ4046

Limit switches

XC Standard range, industrial format EN 50041

Metal, conforming to GENELEC EN 50041, XCKJ

Fixed or plug-in body

Adaptable sub-assemblies for low temperature applications (-40°C)

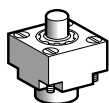

ZCKE616

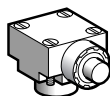

ZCKE636

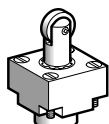

ZCKE626

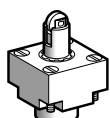

ZCKE676

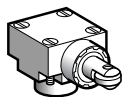

ZCKE646

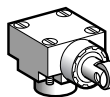

ZCKE656

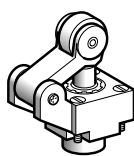

ZCKE216

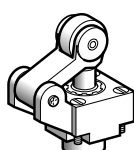

ZCKE236

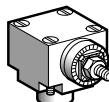

ZCKE056

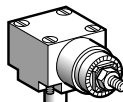

ZCKE096

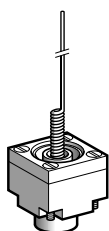

ZCKE066

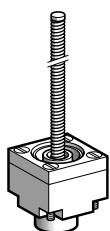

ZCKE086

Plunger heads

Type of operator	Compatible bodies	Maximum actuation speed	Positive operation (1)	Reference	Weight kg	
For actuation on end						
End plunger metal	ZCKJ●, ZCKJ●●	0.5 m/s	⊕	ZCKE616	0.140	
Side plunger metal	ZCKJ●, ZCKJ●●, except ZCKJ4 and J41	0.5 m/s	⊕	ZCKE636	0.200	
For actuation by 30° cam						
Roller plunger steel	ZCKJ●, ZCKJ●●	1 m/s	⊕	ZCKE626	0.155	
End reinforced roller plunger steel	ZCKJ●, ZCKJ●●	1 m/s	⊕	ZCKE676	0.155	
Side roller plunger steel	Horizontal	ZCKJ●, ZCKJ●●, except ZCKJ4 and J41	0.6 m/s	⊕	ZCKE646	0.205
	Vertical	ZCKJ●, ZCKJ●●, except ZCKJ4 and J41	0.6 m/s	⊕	ZCKE656	0.205
Roller lever plunger (1 direction of actuation)	Thermoplastic	ZCKJ●, ZCKJ●●	1.5 m/s	⊕	ZCKE216	0.185
	Steel	ZCKJ●, ZCKJ●●	1.5 m/s	⊕	ZCKE236	0.195

Rotary heads (without operating lever)

Type	Compatible bodies	Maximum actuation speed	Positive operation (1)	Reference	Weight kg
Spring return, for actuation from left AND right or from left OR right (see page 25)	ZCKJ●, ZCKJ●●	1.5 m/s by 30° cam	⊕	ZCKE056	0.165
Stay put, for actuation from left AND right (see page 25)	ZCKJ1, J11 ZCKJ2, J21	0.5 m/s	–	ZCKE096	0.190

Multi-directional heads

Type of operator	Compatible bodies	Maximum actuation speed	Positive operation (1)	Reference	Weight kg
For actuation by any moving part					
“Cat’s whisker”	ZCKJ●, ZCKJ●●, except ZCKJ4 and ZCKJ41	1 m/s in any direction	–	ZCKE066	0.115
Spring rod	ZCKJ●, ZCKJ●●, except ZCKJ4 and ZCKJ41	0.5 m/s in any direction	–	ZCKE086	0.125

(1) ⊕: head assuring positive opening operation.

Limit switches

XC Standard range, industrial format EN 50041

Metal, conforming to CENELEC EN 50041, XCKJ

Fixed or plug-in body

Adaptable sub-assemblies for low temperature applications (- 40°C)



ZCKY1●

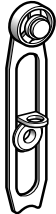

ZCKY4●

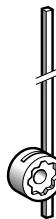

ZCKY51

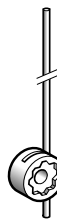

ZCKY5●



ZCKY59



ZCKY81

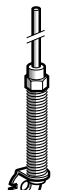

ZCKY91

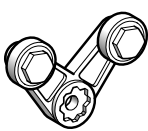

ZCKY71



ZCKY61



XE2SP21●1



XE2NP21●1

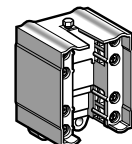

XES P20●1

Operating levers for rotary heads

Description		Positive operation (1)	Reference	Weight kg
For actuation by 30° cam				
Roller lever (2)	Thermoplastic	⊕	ZCKY11	0.025
	Steel	⊕	ZCKY13	0.035
	Steel, ball bearing mounted	⊕	ZCKY14	0.030
Variable length roller lever (3)	Thermoplastic	-	ZCKY41	0.030
	Steel	-	ZCKY43	0.040

For actuation by any moving part

Square rod (2)	∅ 3 mm steel, L = 125 mm	-	ZCKY51	0.025
Round rod (2)	∅ 3 mm steel, L = 125 mm	-	ZCKY53	0.025
	∅ 3 mm glass fibre, L = 125 mm	-	ZCKY52	0.020
	∅ 6 mm thermoplastic, L = 200 mm	-	ZCKY59	0.030
Spring lever (3)		-	ZCKY81	0.020
Spring-metal rod lever (3)		-	ZCKY91	0.025

For actuation by specific cam (only for operation with head ZCKE096)

Forked arm with rollers (2)	1 track	-	ZCKY71	0.035
	2 track	-	ZCKY61	0.035

2-pole and double-pole contact blocks

Type of contact	Scheme	For body	Positive operation (1)	Reference	Weight kg
NC + NO snap action		ZCKJ1	⊕	XE2SP2151	0.020
NC + NO break before make, slow break		ZCKJ5	⊕	XE2NP2151	0.020
2 CO simultaneous, snap action		ZCKJ2	-	XESP2021	0.045
2 CO staggered, snap action		ZCKJ4	-	XESP2031	0.045
NC + NO make before break, slow break		ZCKJ6	⊕	XE2NP2161	0.020
NC + NC simultaneous, slow break		ZCKJ7	⊕	XE2NP2141	0.020
NO + NO simultaneous, slow break		ZCKJ8	-	XE2NP2131	0.020
NC + NC snap action		ZCKJ9	⊕	XE2SP2141	0.020

(1) ⊕: NC contact with positive opening operation or sub-assembly assuring positive opening operation.

(2) Adjustable throughout 360° in 5° steps, or in 45° steps by reversing the lever or its mounting.

(3) Adjustable throughout 360° in 5° steps.

Limit switches

XC Standard range, industrial format EN 50041

Metal, conforming to GENELEC EN 50041, XCKJ

Fixed or plug-in body

Adaptable sub-assemblies for high temperature applications (+ 120°C)

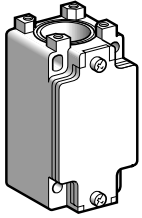

ZCKJ

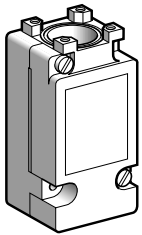

ZCKJ15

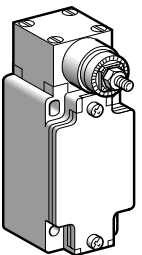

ZCKJ4045

Bodies with contacts		For plunger or rotary head				
Type	With contact block	Scheme	Positive operation (1)	Cable entry	Reference	Weight kg
Fixed bodies						
1 step	2-pole NC + NO snap action (XE2SP2151)		⊕	Pg 13.5	ZCKJ1	0.310
				ISO M20 x 1.5	ZCKJ1H29	0.310
				1/2" NPT	ZCKJ1H7	0.310
	Double-pole 2 CO simultaneous, snap action (XESP20215)		-	Pg 13.5	ZCKJ25	0.310
				ISO M20 x 1.5	ZCKJ25H29	0.310
				1/2" NPT	ZCKJ25H7	0.310
	2-pole NC + NO break before make, slow break (XE2NP2151)		⊕	Pg 13.5	ZCKJ5	0.310
				ISO M20 x 1.5	ZCKJ5H29	0.310
				1/2" NPT	ZCKJ5H7	0.310
	2-pole NO + NC make before break, slow break (XE2NP2161)		⊕	Pg 13.5	ZCKJ6	0.310
ISO M20 x 1.5				ZCKJ6H29	0.310	
1/2" NPT				ZCKJ6H7	0.310	
2-pole NC + NC simultaneous, slow break (XE2NP2141)		⊕	Pg 13.5	ZCKJ7	0.310	
			ISO M20 x 1.5	ZCKJ7H29	0.310	
			1/2" NPT	ZCKJ7H7	0.310	
2-pole NO + NO simultaneous, slow break (XE2NP2131)		-	Pg 13.5	ZCKJ8	0.310	
			ISO M20 x 1.5	ZCKJ8H29	0.310	
			1/2" NPT	ZCKJ8H7	0.310	
2-pole NC + NC snap action (XE2SP2141)		⊕	Pg 13.5	ZCKJ9	0.310	
			ISO M20 x 1.5	ZCKJ9H29	0.310	
			1/2" NPT	ZCKJ9H7	0.310	
2 step	Double-pole 2 CO staggered, snap action (XESP20315)		-	Pg 13.5	ZCKJ45	0.310
				ISO M20 x 1.5	ZCKJ45H29	0.310
				1/2" NPT	ZCKJ45H7	0.310
Plug-in bodies						
1 step	Single-pole CO snap action		-	Pg 13.5	ZCKJ115	0.300
				ISO M20 x 1.5	ZCKJ115H29	0.300
				1/2" NPT	ZCKJ115H7	0.300
	Double-pole 2 CO simultaneous, snap action		-	Pg 13.5	ZCKJ215	0.300
				ISO M20 x 1.5	ZCKJ215H29	0.300
				1/2" NPT	ZCKJ215H7	0.300
2 step	Double-pole 2 CO staggered, snap action		-	Pg 13.5	ZCKJ415	0.300
				ISO M20 x 1.5	ZCKJ415H29	0.300
				1/2" NPT	ZCKJ415H7	0.300
Bodies with contacts		With spring return rotary head (without operating lever)				
Type	With contact block	Scheme	Positive operation (1)	Cable entry	Reference	Weight kg
Fixed body						
2 step 1 from the left AND 1 from the right	Double-pole 2 CO staggered, snap action		-	Pg 13.5	ZCKJ4045	0.455
				ISO M20 x 1.5	ZCKJ4045H29	0.455
				1/2" NPT	ZCKJ4045H7	0.455
Plug-in body						
2 step 1 from the left AND 1 from the right	Double-pole 2 CO staggered, snap action		-	Pg 13.5	ZCKJ41045	0.465
				ISO M20 x 1.5	ZCKJ41045H29	0.465
				1/2" NPT	ZCKJ41045H7	0.465

(1) ⊕: head assuring positive opening operation.

Limit switches

XC Standard range, industrial format EN 50041

Metal, conforming to CENELEC EN 50041, XCKJ

Fixed or plug-in body

Adaptable sub-assemblies for high temperature applications (+ 120°C)

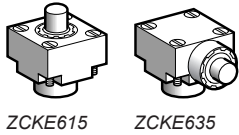

ZCKE615 ZCKE635

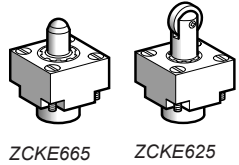

ZCKE665 ZCKE625

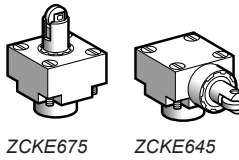

ZCKE675 ZCKE645

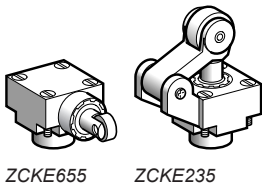

ZCKE655 ZCKE235

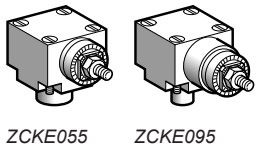

ZCKE055 ZCKE095

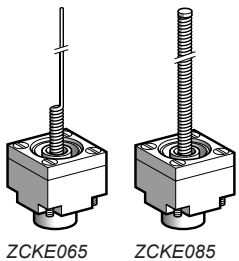

ZCKE065 ZCKE085

Plunger heads						
Type of operator		Compatible bodies	Maximum actuation speed	Positive operation (1)	Reference	Weight kg
For actuation on end						
End plunger	Metal	ZCKJ1, J2, J4, ZCKJ115, J215, J415, ZCKJ5, J6, J7, J8, J9	0.5 m/s	⊕	ZCKE615	0.140
Side plunger	Metal	ZCKJ1, J2, ZCKJ115, J215, ZCKJ5, J6, J7, J8, J9	0.5 m/s	⊕	ZCKE635	0.200
For actuation by 30° cam						
End ball bearing plunger	Steel	ZCKJ1, J2, J4, ZCKJ115, J215, J415, ZCKJ5, J6, J7, J8, J9	0.1 m/s	⊕	ZCKE665	0.150
End roller plunger	Steel	ZCKJ1, J2, J4, ZCKJ115, J215, J415, ZCKJ5, J6, J7, J8, J9	1 m/s	⊕	ZCKE625	0.155
End reinforced roller plunger	Steel	ZCKJ1, J2, J4, ZCKJ115, J215, J415, ZCKJ5, J6, J7, J8, J9	1 m/s	⊕	ZCKE675	0.155
Side roller plunger	Steel Horizontal	ZCKJ1, J2, ZCKJ115, J215, ZCKJ5, J6, J7, J8, J9	0.6 m/s	⊕	ZCKE645	0.205
	Steel Vertical	ZCKJ1, J2, ZCKJ115, J215, ZCKJ5, J6, J7, J8, J9	0.6 m/s	⊕	ZCKE655	0.205
Roller lever plunger (1 direction of actuation)	Steel	ZCKJ1, J2, J4, ZCKJ115, J215, J415, ZCKJ5, J6, J7, J8, J9	1.5 m/s	⊕	ZCKE235	0.195
	Thermoplastic	ZCKJ1, J2, J4, ZCKJ115, J215, J415, ZCKJ5, J6, J7, J8, J9	1.5 m/s	⊕	ZCKE215	0.185
Rotary heads (without operating lever)						
Type		Compatible bodies	Maximum actuation speed	Positive operation (1)	Reference	Weight kg
Spring return, for actuation from left AND right or from left OR right (see page 25)		ZCKJ1, J2, J4, ZCKJ115, J215, ZCKJ415, ZCKJ5, J6, J7, J8, J9	1.5 m/s by 30° cam	⊕	ZCKE055	0.165
Stay put, actuation from left AND right (see page 25)		ZCKJ1, J2, ZCKJ115, J215	0.5 m/s	–	ZCKE095	0.190
Multi-directional heads						
Type of operator		Compatible bodies	Maximum actuation speed	Positive operation (1)	Reference	Weight kg
For actuation by any moving part						
“Cat’s whisker”		ZCKJ1, J2, ZCKJ115, J215, ZCKJ5, J6, J7, J8, J9	1 m/s in any direction	–	ZCKE065	0.115
Spring rod		ZCKJ1, J2, ZCKJ115, J215, ZCKJ5, J6, J7, J8, J9	0.5 m/s in any direction	–	ZCKE085	0.125

(1) ⊕: head assuring positive opening operation.

Limit switches

XC Standard range, industrial format EN 50041

Metal, conforming to GENELEC EN 50041, XCKJ

Fixed or plug-in body

Adaptable sub-assemblies for high temperature applications (+ 120°C)



ZCKY1●



ZCKY43



ZCKY51

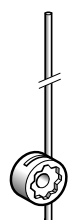

ZCKY5●

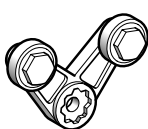

ZCKY715



ZCKY615



XE2SP21●1

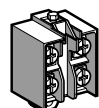

XE2NP21●1

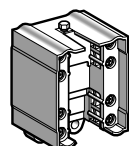

XESP20●15

Operating levers for rotary heads

Description		Positive operation (1)	Reference	Weight kg
For actuation by 30° cam				
Roller lever (2)	Thermoplastic	⊕	ZCKY115	0.025
	Steel	⊕	ZCKY13	0.035
	Steel, ball bearing mounted	⊕	ZCKY14	0.030
Variable length roller lever (3)	Thermoplastic	–	ZCKY415	0.030
	Steel	–	ZCKY43	0.040
For actuation by any moving part				
Square rod (2)	∅ 3 mm steel, L = 125 mm	–	ZCKY51	0.025
Round rod (2)	∅ 3 mm steel, L = 125 mm	–	ZCKY53	0.025
	∅ 3 mm glass fibre, L = 125 mm	–	ZCKY52	0.020

For actuation by specific cam (only for operation with head ZCKE095)

Forked arm with rollers (2)	1 track	–	ZCKY715	0.035
thermoplastic	2 track	–	ZCKY615	0.035

2-pole and double-pole contact blocks

Type of contact	Scheme	For bodies	Positive operation (1)	Reference	Weight kg
NC + NO snap action		ZCKJ1	⊕	XE2SP2151	0.020
NC + NO break before make, slow break		ZCKJ5	⊖	XE2NP2151	0.020
2 CO simultaneous, snap action		ZCKJ25	–	XESP20215	0.045
2 CO staggered, snap action		ZCKJ45	–	XESP20315	0.045
NC + NO make before break, slow break		ZCKJ6	⊖	XE2NP2161	0.020
NC + NC simultaneous, slow break		ZCKJ7	⊖	XE2NP2141	0.020
NO + NO simultaneous, slow break		ZCKJ8	–	XE2NP2131	0.020
NC + NC snap action		ZCKJ9	⊕	XE2SP2141	0.020

(1) ⊕: NC contact with positive opening operation or sub-assembly assuring positive opening operation.

(2) Adjustable throughout 360° in 5° steps, or in 45° steps by reversing the lever or its mounting.

(3) Adjustable throughout 360° in 5° steps.